

3-Way Temperature Control Valve

Model G, Version G and Accessories

Typical applications

For engines, turbines, gearboxes and heat exchangers:

- Charge air cooling
- Secondary cooling systems
- Fuel and lube oil preheating
- Co-generation
- Engine jacket water

For refineries, chemical plants and oil reproduction:

- Waste heat boilers
- Product coolers
- Product heaters
- Product condensers

Key benefits

- Ease of integration - valve size matches pipe size, resulting in reduced installation time and installation costs
- Flexible design - ports can be configured to suit installation
- Low pressure drop - compared to other valve types
- Small physical size
- Hand wheel allows manual adjustment of valve (optional on pneumatic valve) - simplified set up and maintenance

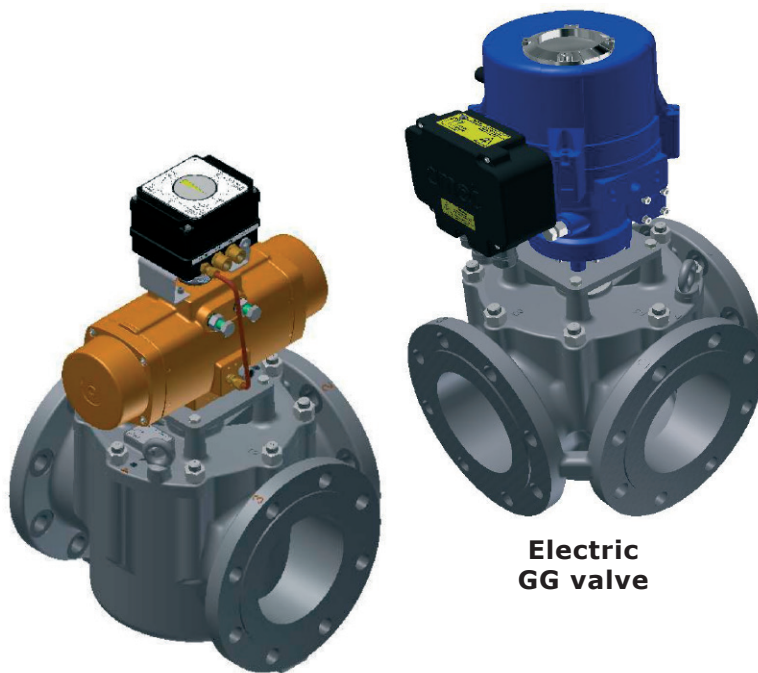

Pneumatic GG valve

Electric GG valve

G valve compared with a typical equivalent competitor's specification.



Now even more compact

amot

Contents

Overview	3
Applications	3
System Types	4
Overview of Valve Body	6
Specification	6
Modes of Operation	7
Valve Sizing	9
Dimensions	13
Overview of Electric Actuation	15
Electronic Positioner	16
Overview of Pneumatic Actuation	16
How to Order	17
Accessories	18
PID Controller 8071D, 8072D, SSR 47581....	18
3-Wire PT 100 Temperature Sensor 8060	18
Solid State Relay Module 8073C	19
Electro Pneumatic Converter 8064A	19
Electro Pneumatic Converter 8064C	20
Pneumatic Indicator Controller SG80	20

3-Way Temperature Control Valve - Model G, Version G

Overview

AMOT G valves are 3-way control valves consisting of a heavy duty rotary valve and either a quarter turn electric or pneumatic actuator. The valves provide a high degree of accuracy and repeatability for accurate temperature control and are equally accurate in mixing or diverting service over a wide flow range.

The heavy duty rotor design provides tight temperature control without high maintenance requirements. The system is available in three standard control configurations: electric; pneumatic; and electro-pneumatic, offering flexibility for most requirements. Designed

for high vibration service, the AMOT G valves are qualified to Lloyd's Marine Requirements for shipboard service. Valves can be directly mounted to reciprocating machinery, such as diesel engines, without vibration isolation. The heavy duty actuators are specially reinforced to provide vibration resistance.

The standard valves are suitable for a variety of fluids such as water, water/glycol, sea water, lubricating and hydraulic oils. Optional body materials are available for services involving synthetic or fire resistant oils, deionized water and ammonia or freon in oil.

Applications

Mixing Applications

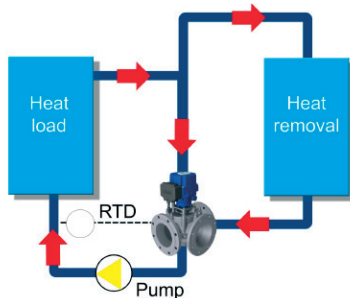

Lubricating oil temperature control is normally configured in a mixing application controlling the return temperature to the heat load. The temperature is normally measured as close as possible to the sump return.

Diverting Applications

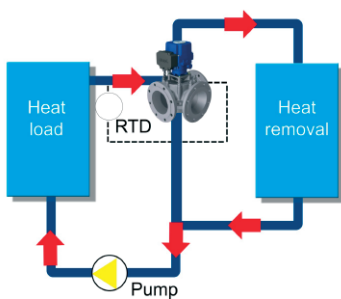

Jacket water cooling in diverting applications regulates the outlet coolant water temperature from a diesel or gas engine. The valve either sends water to a cooler or bypass loop, accurately maintaining the temperature.

The temperature is normally measured at the outlet from the heat source.

Charge Air Temperature Control

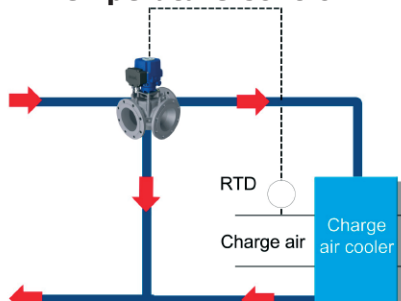

The intercooler is used to cool high temperature turbo charger air.

In this application the G Valve regulates the flow of cooling water through an intercooler, increasing efficiency, enhancing performance and helping to meet today's environmental requirements.

3-Way Temperature Control Valve - Model G, Version G

System Types

Electric Valve



Electric GG Valve

For the electric valve, the actuator of the G valve assembly uses an electric motor which rotates in either direction in response to the ON-OFF signals received. The motor drives a gearbox connected to the rotor shaft and turns the valve rotor clockwise or counter-clockwise, a maximum of 90 degrees. At the end of travel, limit switches are incorporated to isolate the electrical supply to the motor when the valve rotor has reached either end of the rotation. A feedback hall sensor is standard and provides position indication to the control system.

The electric actuator is a rugged, compact and lightweight quarter turn actuator having enclosure protection to IP65.

The actuator is powered by an electric motor driving a worm-type gearbox. The worm gearbox prevents reverse drive due to fluid forces. It is fitted with manual override as standard, enabling valve operation without power.

A thermal cutout is fitted preventing overheating. Limit switches at each end of stroke disconnect motor power when end stroke is reached. These can also be used for remote indication.

See page 15 for more information on the electric actuator.

Electric System



Temperature Probe 8060



PID Controller 8071/2D, IP67 enclosure



GG Valve

The electric valve system incorporates the use of an electrically actuated three-way control valve with an electronic controller. The 8071D PID Controller can be either panel or wall mounted (see page 18 for more information). The system is completed with a temperature sensor type 8060 (see page 18 for details).

The electric G Valve system is simple to install with standard four core cable, and provides more accurate measurement and control than typical pneumatically operated systems.

3-Way Temperature Control Valve - Model G, Version G

System Types continued

Pneumatic Valve

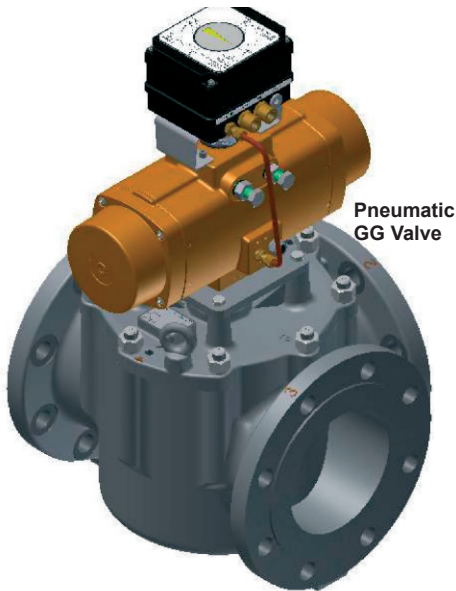

The pneumatic valve uses a spring return pneumatic actuator and positioner to control the rotation of the valve in response to an input signal from a pneumatic or electro-pneumatic control system. The pneumatic control system sends a pneumatic signal ranging from 0.21 to 1.03 bar (3 to 15 psi) to the actuator to correctly position the valve at the desired temperature setting. The pneumatic control system usually consists of a P+I pneumatic controller, sensor and the necessary air supply conditioning equipment (regulators, filters and water traps).

The pneumatic actuator is a rugged, quarter turn, double piston actuator operating on a scotch yoke principle.

The actuator is fitted with spring return as standard allowing fail-safe configuration if necessary. It is also fitted with a valve positioner enabling accurate and repeatable movement. See page 16 for more information on the pneumatic actuator.

Pneumatic System

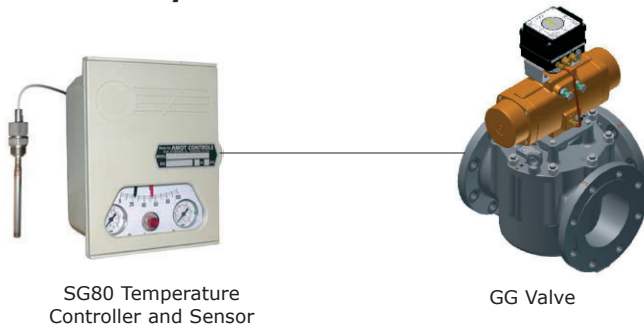

The pneumatic valve system incorporates a pneumatically actuated three-way control valve with controller and integral temperature sensor, the SG80, which can be panel or wall mounted. For more information on the SG80, see page 20. The pneumatic G valve system is ideal when there is a lack of electricity or when a fail-safe system is needed.

Electro-Pneumatic System

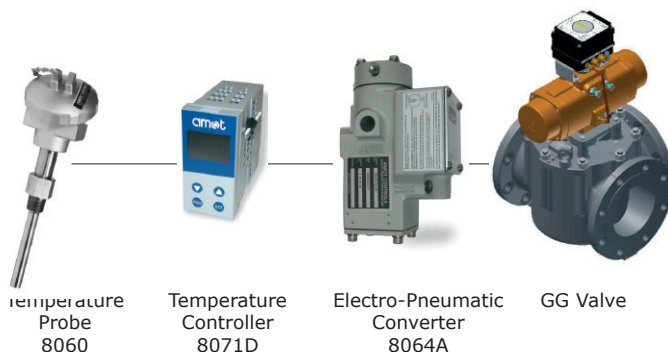

The electro-pneumatic valve system combines both electric and pneumatic technology, consisting of a pneumatically actuated three-way control valve with an electro-pneumatic converter, type 8064A. See page 19 for more details.

The probe sends a resistance signal to the electronic controller, which in turn sends a 4 to 20mA signal to an I/P converter that converts this to a pneumatic signal.

The electro-pneumatic system combines the features and functionality of the AMOT electronic control system with the fail-safe action benefits of a pneumatically actuated valve.

3-Way Temperature Control Valve - Model G, Version G

Overview of Valve Body

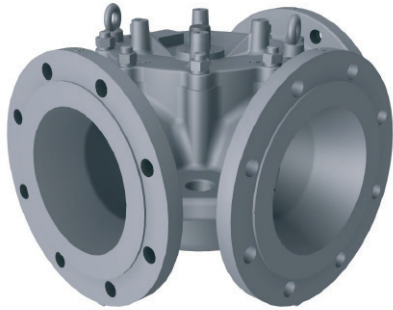

Valve Body

Key features and benefits

- Lightweight and compact
- Configurable ports - allowing flexibility on installation
- Low pressure drop - enables savings on either valve or pump size
- High accuracy providing better temperature control

Specification

Flow to: 720m³/hr 3,170 US gpm
For valves with higher flow rates see datasheet GEF_GPD_Temp_Control_Valve

Sizes:	Standard flow	High flow
	80mm - 200mm (3" - 8")	80mm - 200mm (2" - 8")
	For 250 mm (10") and above see Datasheet GEF_GPD_Temp_Control_Valve	

Body material: Ductile iron High performance iron, for fresh water, lubricating oils

Seal material: Fluorocarbon (Viton, FKM)

Flanges: EN 1092, ASME and JIS standards.

Maximum internal valve pressure: 10 bar (145 psi)

Maximum temperature of fluid: 100°C (212°F)

Vibration: Exceeds the requirements of Lloyd's Register Type Approval System, Test Specification Number 1, 2002, Vibration Test 2.
For both electric and pneumatic:

Frequency range	Displacement	Acceleration	Lloyd's
5 - 25 Hz	+/- 1.6mm		+/- 1.6mm
25 - 100 Hz		+/- 5.0g (49 m/s ²)	+/- 4.0g (39 m/s ²)
100 - 300 Hz		+/- 1.0g (9.81 m/s ²) 90 minute	No requirement

3-Way Temperature Control Valve - Model G, Version G

Modes of Operation - Electrically Actuated

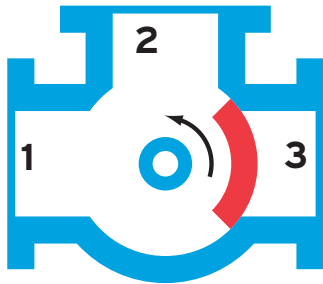

The unique construction of the AMOT G valve provides total flexibility by allowing you to select the valve port positions most ideally suited to meet your application requirements. There are two main types of mode of operation: 90° rotor that allows either ports 1 or 3 to be selected as the common port; and 180° rotor that requires port 2 to be the common port. Arrow indicates valve movement with increasing temperature or mA, as viewed from above (see diagram). For electrically actuated valves, on loss of signal the actuator is set up by default to stop in its current position.

	Electric actuator (switched live input)		Electric actuator direct acting (4-20mA input)		Electric actuator reverse acting (20-4mA input)	
	Cold position	Hot position	4mA (cold)	20mA (hot)	20mA (cold)	4mA (hot)
Mode 32						
Mode 21						
Mode 12						
Mode 23						
Mode 13						
Mode 31						

3-Way Temperature Control Valve - Model G, Version G

Modes of Operation - Pneumatically Actuated

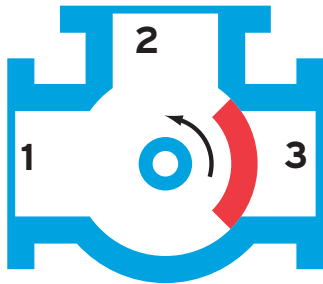

The unique construction of the AMOT G valve provides total flexibility by allowing you to select the valve port positions most ideally suited to meet your application requirements. There are two main types of mode of operation: 90° rotor that allows either ports 1 or 3 to be selected as the common port; and 180° rotor that requires port 2 to be the common port. Arrow indicates valve movement with increasing temperature or mA, as viewed from above (see diagram).

	Pneumatic actuator direct acting			Pneumatic actuator reverse acting		
	3 PSI (cold)	15 PSI (hot)	No signal	15 PSI (cold)	3 PSI (hot)	No signal
Mode 32						
Mode 21						
Mode 12						
Mode 23						
Mode 13						
Mode 31						

3-Way Temperature Control Valve - Model G, Version G

Valve Sizing (Metric units)

Valve Flowrate Selection (Flowrate m³/hr)

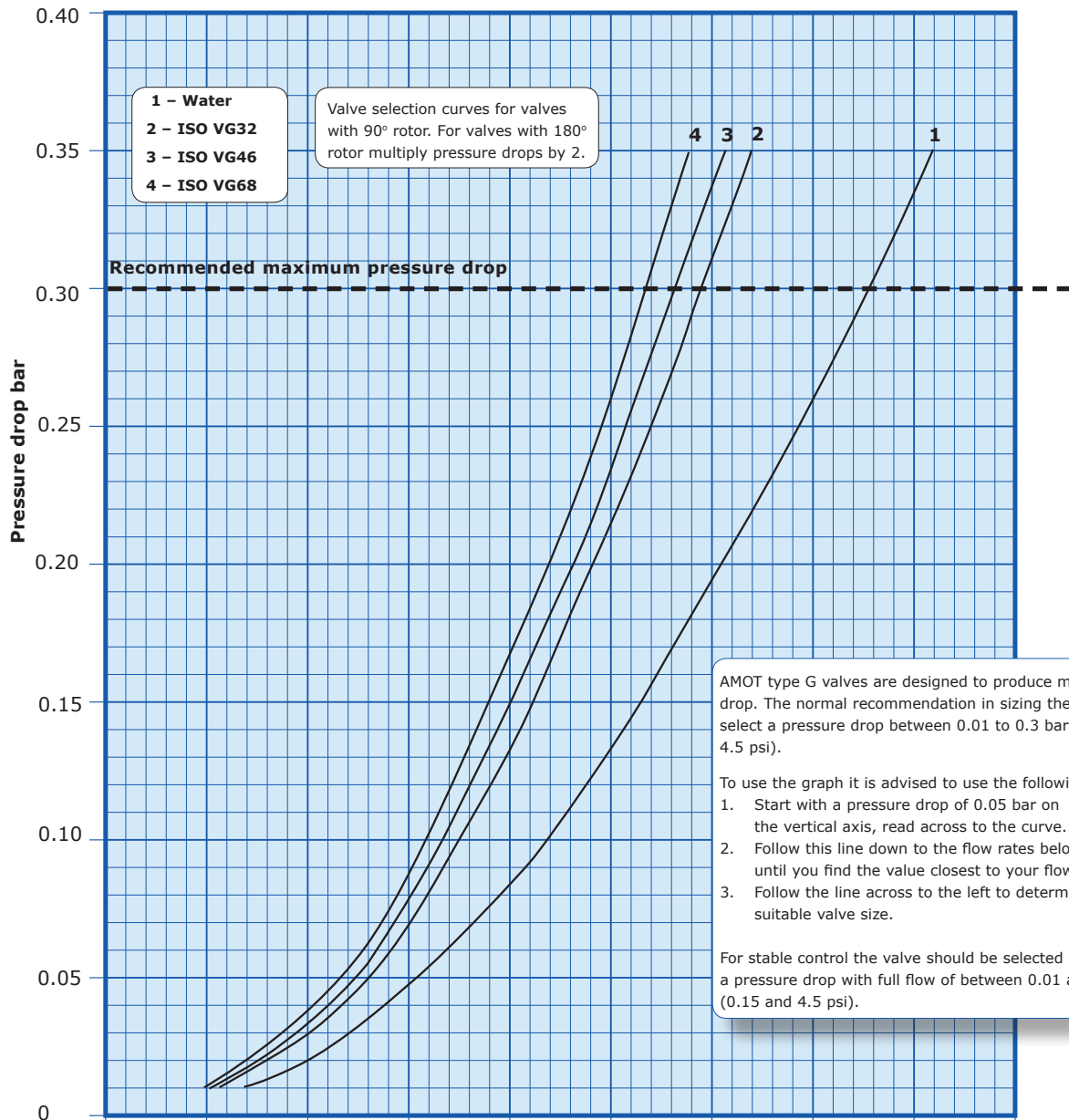

Size DN (inches)	Standard flow	High flow								
80 (3)	50 (2)		7	14	20	26	33	39	46	52
100 (4)	80 (3)		19	35	51	67	83	99	115	131
150 (6)	100 (4)		29	54	79	104	129	154	179	204
200 (8)	150 (6)		66	122	178	235	291	347	403	459
	200 (8)		118	218	318	418	517	617	717	817
250 (10)										
300 (12)	250 (10)									
350 (14)	300 (12)									
400 (16)	350 (14)									
450 (18)	400 (16)									

Currently only available in GEF/GPD versions.
See Datasheet GEF_GPD_Temp_Control_Valve for data

3-Way Temperature Control Valve - Model G, Version G

Valve Sizing (English units)

Valve Flowrate Selection (Flowrate USg/m)

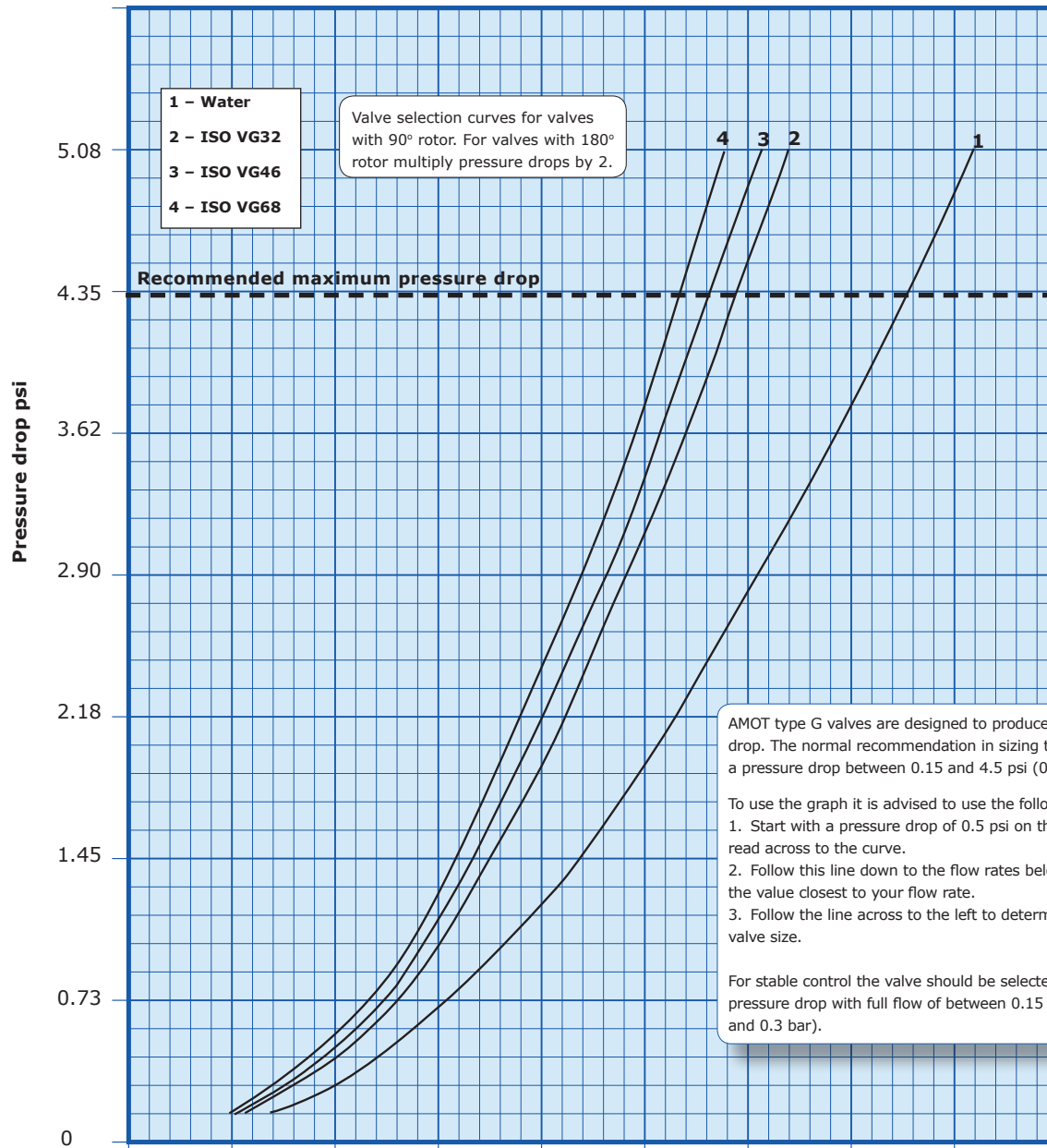

Size inches (DN)	Standard flow		High flow							
	3 (80)	2 (50)	31	62	88	114	145	172	203	229
4 (100)	3 (80)		84	154	225	295	365	436	506	577
6 (150)	4 (100)		128	238	348	458	568	678	788	898
8 (200)	6 (150)		291	537	784	1035	1281	1528	1774	2021
	8 (200)		520	960	1400	1840	2276	2717	3157	3597
10 (250)										
12 (300)	10 (250)									
14 (350)	12 (300)									
16 (400)	14 (350)									
18 (450)	16 (400)									

Currently only available in GEF/GPD versions.
See Datasheet GEF_GPD_Temp_Control_Valve for data

3-Way Temperature Control Valve - Model G, Version G

Valve Sizing

Viscosity Correction

Example:

From the graph below:

100 cSt = correction factor of 0.68

$0.68 \times \text{flow coefficient} = \text{corrected flow coefficient (Kv or Cv)}$

Some approximate viscosities (cSt) of SAE oils at 40°C (110°F) are shown below, based on leading oil manufacturers published data.

For the selection of valves for more viscous fluids than water, the following must be calculated:

Viscosity: Find the viscosity of the fluid in which the valve is to operate. The viscosity is normally expressed in centistokes. Where ISO oil is used, the grade number is also the viscosity eg ISO VG46 is 46 centistokes at 40°C (104°F).

Viscosity correction: By using the correction graph below, the flow coefficient correction factor can be established. The correction figure obtained from the graph should then be multiplied by the original flow coefficient which can then be used in the standard valve sizing formulae.

Viscosity Correction Curve (Fv)

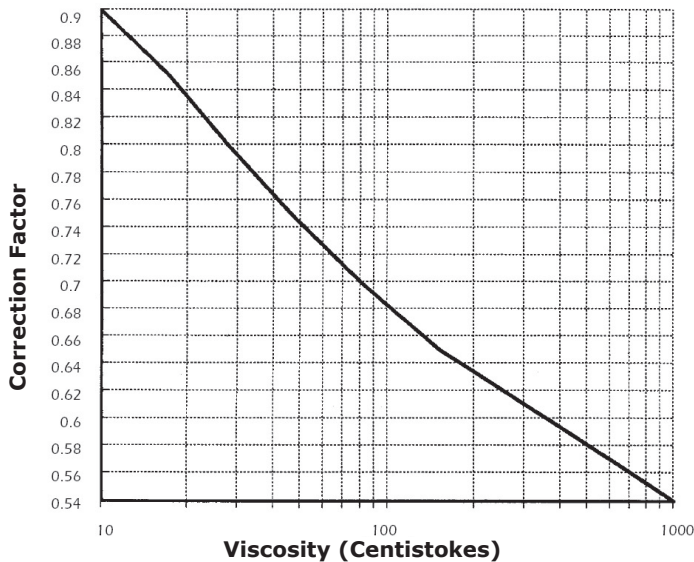

Some approximate viscosities (cSt) of SAE oils at 40°C (104°F) are shown below, based on leading oil manufacturers' published data.

SAE Oil Viscosities

Engine oils	
Oil	cSt
SAE 5W	6.8
SAE 10W	32
SAE 20	46
SAE 20W	68
SAE 30	100
SAE 40	150
SAE 50	220

Gear oils	
Oil	cSt
SAE 75W	22
SAE 80W	46
SAE 85W	100
SAE 90	150
SAE 140	460

3-Way Temperature Control Valve - Model G, Version G

Valve Sizing

Valve Sizing Calculations

Valve Flowrate

See the table below for examples of Kv and Cv:

Size DN (in)	Standard flow	80 (3)	100 (4)	150 (6)	200 (8)	250 (10)	300 (12)	350 (14)	400 (16)	450 (18)
	High flow	50 (2)	80 (3)	100 (4)	150 (6)	200 (8)	250 (10)	300 (12)	350 (14)	400 (16)
Kv		82	207	323	729	1296				
Cv		96	242	378	851	1513				

Currently only available in GEF/GPD versions.
See Datasheet GEF_GPD_Temp_Control_Valve for data

Pressure Drop

The G valve is designed to produce minimal pressure drop. The normal recommendation when determining the size of an AMOT G valve is a pressure drop between 0.01 and 0.3 bar (0.15 and 4.5 psi). **Note:** Kv and Cv values are applicable to 90° rotor versions only.

Kv is the flow coefficient in metric units. It is defined as the flow rate in cubic meters per hour (m³/h) of water at a temperature of 16° celsius with a pressure drop across the valve of 1 bar. Cv is the imperial coefficient. It is defined as the flow rate in US Gallons per minute [gpm] of water at a temperature of 60° fahrenheit with a pressure drop across the valve of 1 psi. (Kv = 0.865 Cv / Cv = 1.156 Kv)

The basic formula to determine the Kv of a valve is:

$$Kv = Q \sqrt{\frac{SG}{Dp}}$$

Q = Flow (m³/h)
Dp = Pressure drop (bar)
SG = Specific gravity of fluid
Kv = Valve flow coefficient

There are two other ways that this formula can be used to find the flow in m³/h or pressure drop of a valve in bar:

$$Q = Kv \sqrt{\frac{Dp}{SG}} \quad Dp = \left[\frac{Q}{Kv} \right]^2 SG$$

The basic formula to determine the Cv of a valve is:

$$Cv = Q \sqrt{\frac{SG}{Dp}}$$

Q = Flow (US gallons/min)
Dp = Pressure drop (psi)
SG = Specific gravity of fluid
Cv = Valve flow coefficient

There are two other ways that this formula can be used to find the flow in US gallons/minute or pressure drop of a valve in PSI:

$$Q = Cv \sqrt{\frac{Dp}{SG}} \quad Dp = \left[\frac{Q}{Cv} \right]^2 SG$$

Valve Bypass Flowrates

The AMOT G Valve is not a tight shutoff valve. When used in a reasonably balanced pressure system there will be some small amounts of leakage between ports. The actual amount of leakage will vary with the pressure difference

between these ports. Consult AMOT for further information if the application is sensitive to leakage rates or if high pressure differences are likely to occur.

3-Way Temperature Control Valve - Model G, Version G

Dimensions

Electrically Actuated with
Manual Override

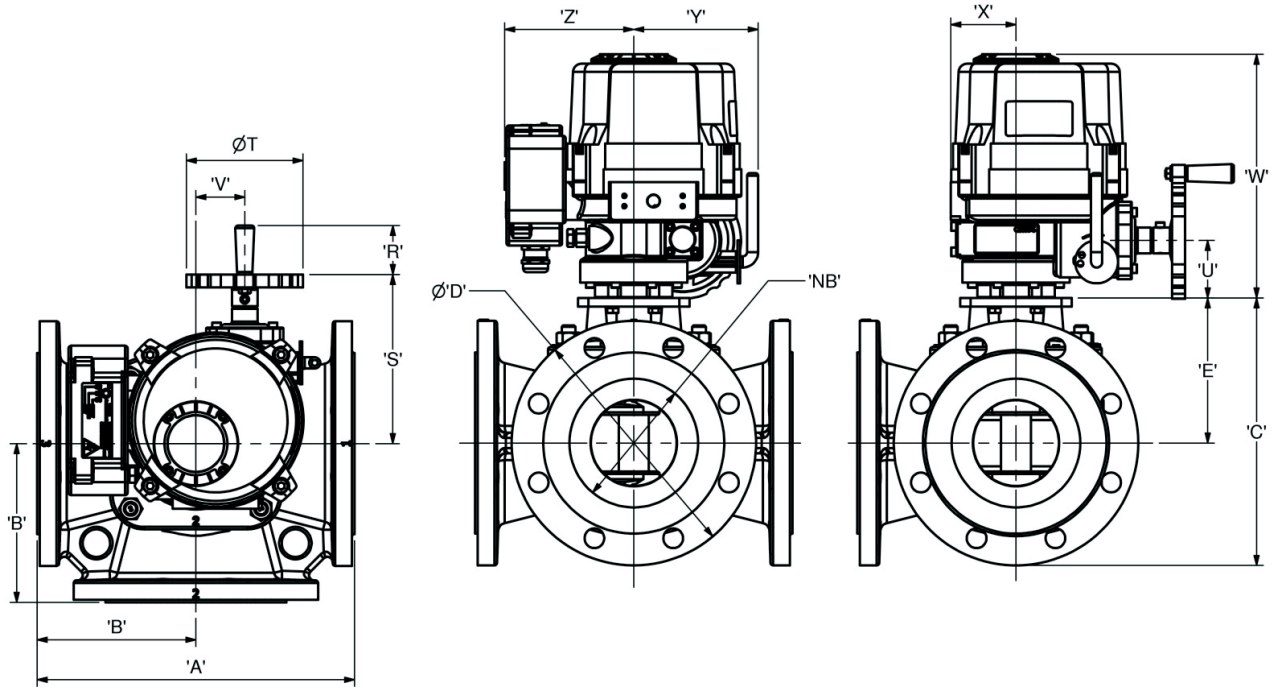

Pneumatically
Actuated

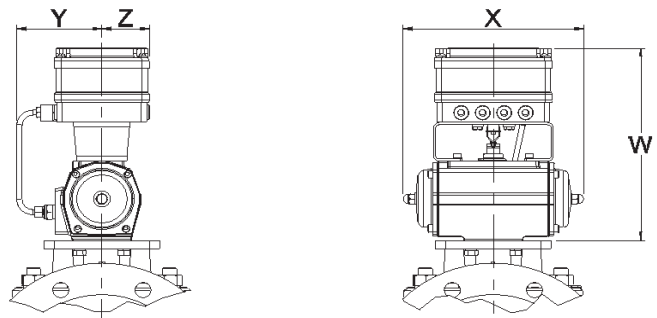

Pneumatically Actuated
with Manual Override

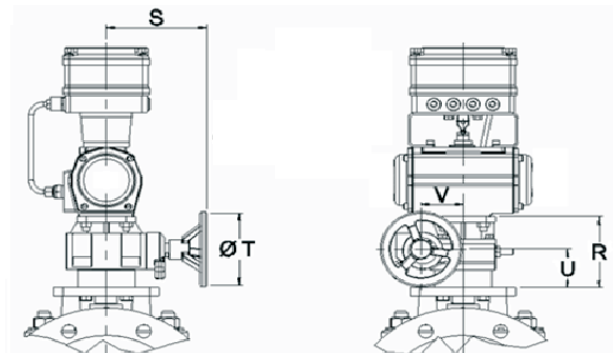

See page 14
for dimensions

3-Way Temperature Control Valve - Model G, Version G

Dimensions continued

Dimensions in mm

Valve Type	Valve Body						Electrically Actuated								Pneumatically Actuated								Valve Type																													
	NB	A	B	C	D	E	R	S	T	U	V	W	X	Y	Z	R*	S*	T*	U*	V*	W	X		Y	Z																											
03GGS	80	280	140	207	200	107	57	197	136	67	57	284	76	145	151	95	123	100	52	52	245	192	95	53	03GGS																											
03GGH				227	200	127																			03GGH																											
04GGS	100	300	150	242	229	128										57	197	136	67	57	284	76	145	151	95	123	100	52	52	245	192	95	53	04GGS																		
04GGH				281	224	169																												04GGH																		
05GGS	125	340	170	296	254	169																			57	197	136	67	57	284	76	145	151	95	123	100	52	52	245	192	95	53	05GGS									
06GGS	150	370	185	312	285	169																																					06GGS									
06GGH				346	285	191																												06GGH																		
08GGS	200	450	225	371	343	191																												57	197	136	67	57	284	76	145	151	100	155	200	45	79	297	362	115	53	08GGS
08GGH				113	08GGH																																															

Dimensions in inches

Valve Type	Valve Body						Electrically Actuated								Pneumatically Actuated								Valve Type																													
	NB	A	B	C	D	E	R	S	T	U	V	W	X	Y	Z	R*	S*	T*	U*	V*	W	X		Y	Z																											
03GGS	3.00	11.02	5.51	8.15	7.87	4.21	2.24	7.76	5.35	2.64	2.24	11.18	2.99	5.71	5.95	3.74	4.84	3.94	2.05	2.05	9.65	7.56	3.74	2.09	03GGS																											
03GGH				8.94	7.87	5.00																			03GGH																											
04GGS	4.00	11.81	5.91	9.53	9.02	5.04										2.24	7.76	5.35	2.64	2.24	11.18	2.99	5.71	5.95	3.74	4.84	3.94	2.05	2.05	9.65	7.56	3.74	2.09	04GGS																		
04GGH				11.06	8.82	6.65																												04GGH																		
05GGS	5.00	13.39	6.69	11.65	10.00	6.65																			2.24	7.76	5.35	2.64	2.24	11.18	2.99	5.71	5.95	3.74	4.84	3.94	2.05	2.05	9.65	7.56	3.74	2.09	05GGS									
06GGS	6.00	14.57	7.28	12.28	11.22	6.65																																					06GGS									
06GGH				13.62	11.22	7.52																												06GGH																		
08GGS	8.00	17.72	8.86	14.61	13.50	7.52																												2.24	7.76	5.35	2.64	2.24	11.18	2.99	5.71	5.95	3.94	6.10	7.87	1.77	3.11	11.69	14.25	4.53	2.09	08GGS
08GGH				4.45	08GGH																																															

* Relevant only to pneumatic actuator with manual override version.

Bolthole dimensions are as per the relevant specification chosen in the model coding. Full dimensional details can be provided on request.

3-Way Temperature Control Valve - Model G, Version G

Overview of Electric Actuation



Electric Actuator

Key features and benefits

- Self-locking with minimum backlash in the transmission - prevents valve movement due to flow
- Auxiliary limit switches for user connection
- Manual override fitted as standard - valve can be operated in event of power failure
- Two torque switches - provide protection in event of actuator overloading

Specification

Power	115V ± 10% or 230V ± 10%	50/60Hz single phase
Limit switches	Two open/close SPDT	250V AC, 10A
Motor thermal protection	Fitted as standard	
Angular rotation	110° max	Quarter turn
Position sensor	Contactless half effect	
Cable entry	2 x M25 x 1.5	IP68 glands provided
Mechanical stop	Two adjustable screws	
Manual override	Fitted as standard	
Materials	Steel, aluminum alloy, aluminum bronze, polycarbonate	
External coating	Dry powder polyester	
Weatherproof enclosure	IP67, NEMA 4 and 6	
Ambient temperature	-20°C to +70°C	(-4°F to +158°F)
Ambient humidity	90% RH max (non-condensing)	
Anti-condensation heater	7 - 10W	
Vibration resistance	5 - 100 Hz	5g
	100 - 300 Hz	1g
Performance	Duty cycle 20°C	Stroke time (secs)
Standard	High flow	Max current (A)
		50 Hz 60 Hz 220V 110V
	50	Currently only available in GEF/GPD versions. See Datasheet GEF_GPD_Temp_Control_Valve for data
80 - 200	80 - 200	65% 25 21 0.88 1.7
250 - 450	250 - 400	Currently only available in GEF/GPD versions. See Datasheet GEF_GPD_Temp_Control_Valve for data

3-Way Temperature Control Valve - Model G, Version G

Electronic Positioner

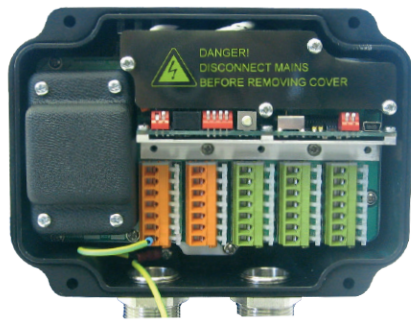

Electronic Positioner

The AMOT actuator/valve positioner is configured to accept an industry standard 4-20mA position demand input signal, and uses this to operate internal solid state switching to drive the motor.

The microprocessor based unit uses the signal from the contactless position sensor to accurately position the actuator, taking into account motor response time and actuator overshoot.

The positioner is split into two parts, housed in the terminal box. There is a power module, in which all high voltage circuits are fully encapsulated to withstand high vibration, and a control board. This design allows for easy maintenance.

There are three LEDs on the terminal box on the side of the actuator, providing clear visual indication of actuator status. Two alarm outputs allow for remote fault monitoring.

User configuration allows:

- The input can be selected from 4-20mA, 0-20mA, 0-5V, 0-10V and 2-10V by switches.
- 4-20mA output, which shows actual valve position, can be configured to retransmit the demand input signal.
- A switch allows for easy configuration of which end of stroke corresponds with a 4mA demand.
- The action on sensor fail can be selected from moving to either the 4mA or the 20mA positions, but is factory set to not moving.
- The deadband can be increased to aid performance with noisy input signals.
- When necessary, such as after maintenance, the actuator can be recalibrated at the touch of a button.

Overview of Pneumatic Actuation



Pneumatic Actuator

Key features and benefits

- A rugged quarter turn, double piston, rack and pinion pneumatic actuator with spring return and valve positioner as standard.
- Can be configured fail-safe

Specification

Housing	Cast aluminum base, steel cover and two part Polyurethane paint finish.	
Supply pressure	6 to 8 bar	(90 to 115 psi)
Signal pressure	0.21 to 1.03 bar	(3 to 15 psi)
Pressure connections	G 1/4	(1/4 NPT)
Manual override	Optional	

3-Way Temperature Control Valve - Model G, Version G

How to Order

Use the table below to select the unique specification of your G valve:

Example Code	06GG	S	D	B	S	32	EA	B	CA	-AA	Code Description				
Valve Body Selection	Valve Size & Model	02GG									Nominal Bore Size		Comments		
		03GG									2 Inch (DN50)		High Flow Only		
		04GG									3 Inch (DN80)				
		05GG									4 Inch (DN100)				
		06GG									5 Inch (DN125)		Standard Flow only		
		06GG									6 Inch (DN150)				
		08GG									8 Inch (DN200)				
	Valve Flow Type											Valve Flow Type (Refer to flow coefficient table for Cv/Kv data)			
		S											Standard Flow Valve		
	Valve Body											High Flow Valve			
		D											Body Material Ductile Iron		
	Valve Flange Connection Standard and Class											Flange Class	Flange Standard	Flat / Raised Face	
		A											PN6	EN 1092	Raised
		B											PN10	EN 1092	Raised
		C											PN16	EN 1092	Raised
F												125 lb (Flat Face)	ASME	Flat	
J												150 lb	ASME	Raised	
L												10K	JIS	Flat	
Rotor Type											Rotor Type				
	S											Standard Rotor			
Valve Mode of Operation											Rotor Position		Rotation Starting From Cold Position		
											Cold Process	Hot Process			
	12											Port 1	Port 2	Clockwise	
	23											Port 2	Port 3		
	31											Port 3	Port 1		
	21											Port 2	Port 1	Anticlockwise	
	32											Port 3	Port 2		
13											Port 1	Port 3			
Actuator Selection	Valve Actuation Type Electric Actuator Power Supply Pneumatic Actuator Air Connections & Manual override	Elec	EA									Power Supply		Air Connection	Manual override
			EB									100 -120 Vac 50/60Hz	-	Fitted as Standard	
		Pneu	P1											-	-
			P2											G1/4 (1/4" BSPP)	Not Fitted
			P3											1/4" NPT	
	P4											-	G1/4 (1/4" BSPP)	Fitted	
	Actuator Control Input Signal	Elec	A										Input Signal		Comments
			B										Relays, Switched Live Supply		
			C										4-20mA		
		Pne	1										20-4mA		On Increasing Temperature
2												3-15psi			
Actuator Feedback Signal											Feedback Signal				
	Electric	AA										None	Not applicable for Actuator Control Input Signal codes B or C		
		CA										4-20mA Position Retransmit			
		EA										20-4mA Position Retransmit			
	Pne	00									None				
Customer Special Options											-AA	Standard Product			
											-***	Customer Special Code Assigned			

3-Way Temperature Control Valve - Model G, Version G

Accessories

PID Valve Controllers 8071/8072D and Solid State Relays 47581L001



**PID Controller
8072D**



**Solid State
Relay
47581L001**



**PID Controller
8071D**

Key features and benefits

- Fully programmable PID-based control - allows easy system configuration
- Universal inputs; RTD's, thermocouple, or standard 4-20mA signal gives maximum system design flexibility
- Can be operated in manual mode - easy maintenance and set up

For further information and how to order these products see [Datasheet_8071_2_D_47851.pdf](#)

3-Wire PT100 Temperature Sensor - 8060



**Temperature Sensor
8060**

Key features and benefits

- 3 wire RTDs - accurate temperature measurement
- Excellent long term stability
- Good linearity
- Can use standard 3-core cable

For further information and how to order this product see [Datasheet_8060_temp_sensor.pdf](#)

3-Way Temperature Control Valve - Model G, Version G

Accessories

Solid State Relay Module - 8073C



Relay Module
8073C

Key features and benefits

- IP67 enclosure
- Alternative to using two SSRs type 47581L001
- Good linearity
- Can use standard 3-core cable

The 8073C relay module incorporates two solid state relays with terminations in an IP67 enclosure. The 8073C is designed to be used with the 8071D controller logic outputs to drive voltages for the electrically actuated G valve. Features include: zero-crossing switching, relay and logic level inputs and IP67 enclosure.

Typical Applications

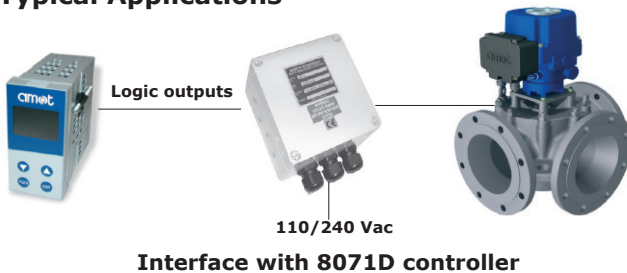

Interface with 8071D controller

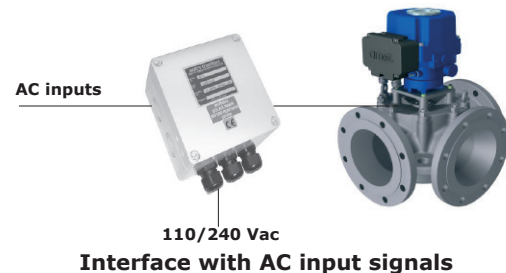

Interface with AC input signals

For further information and how to order this product see [Datasheet_8073C_SSR.pdf](#)

Electro-Pneumatic Converter - 8064A



Electro-Pneumatic
Converter - 8064A

Typical Application

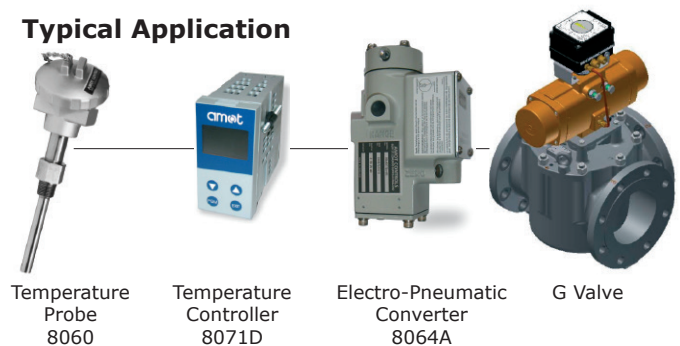

Key features and benefits

- High vibration resistance - Lloyds 4G
- Suitable for longer pipe runs
- Fully adjustable for optimised system operation
- ATEX hazardous area certification

For further information and how to order this product see [Datasheet_8064A_C_elect_pneu_converter.pdf](#)

3-Way Temperature Control Valve - Model G, Version G

Accessories

Electro-Pneumatic Converter - 8064C

Typical Application



Electro-Pneumatic Converter - 8064C

Key features and benefits

- Accepts high supply pressure - avoids use of additional regulator
- Factory set for ease of installation
- Low cost alternative to 8064A
- ATEX hazardous area certification

Electro-pneumatic system

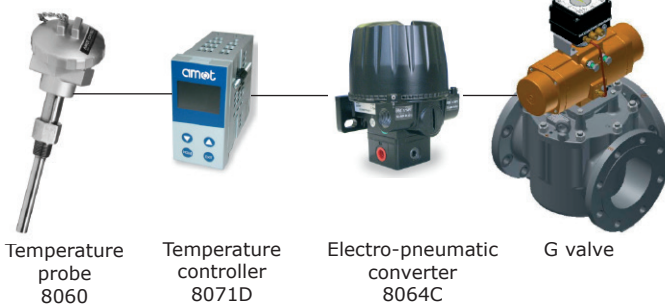

For further information and how to order this product see [Datasheet_8064A_C_elect_pneu_converter.pdf](#)

Pneumatic Indicator Controller - SG80



Pneumatic Indicator Controller SG80

Key features and benefits

- Complete stand alone controller, no other control components required - reduced system cost
- Easily removable components - low maintenance
- Good dynamic response - gives optimum engine performance
- Compatible with every type of pneumatic valve - flexible

Typical Application

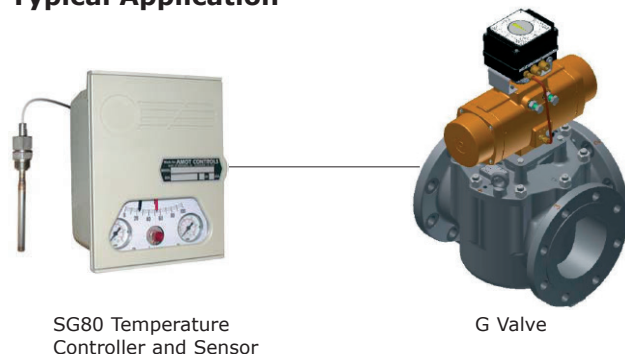

For further information and how to order this product see [Datasheet_SG80_Pneu_Ind_Controller.pdf](#)

Americas

AMOT USA
8824 Fallbrook Dr
Houston
TX 77064
USA

Tel: +1 (281) 940 1800
Fax +1 (713) 559 9419
Email sales@amotusa.com

Asia and Australasia

AMOT Shanghai
Bd. 7A, No 568
Longpan Rd, Malu Jiading
Shanghai 201801
China

Tel +86 (0) 21 5910 4052
Fax +86 (0) 21 5237 8560
Email shanghai@amot.com

Europe and Africa

AMOT
Western Way
Bury St Edmunds
Suffolk, IP33 3SZ
United Kingdom

Tel +44 (0) 1284 762222
Fax +44 (0) 1284 760256
Email info@amot.com

AMOT Controls GmbH
Rondenbarg 25
22525 Hamburg
Germany

Tel +49 (0) 40 8537 1298
Fax +49 (0) 40 8537 1331
Email germany@amot.com